

FIG. 1

20

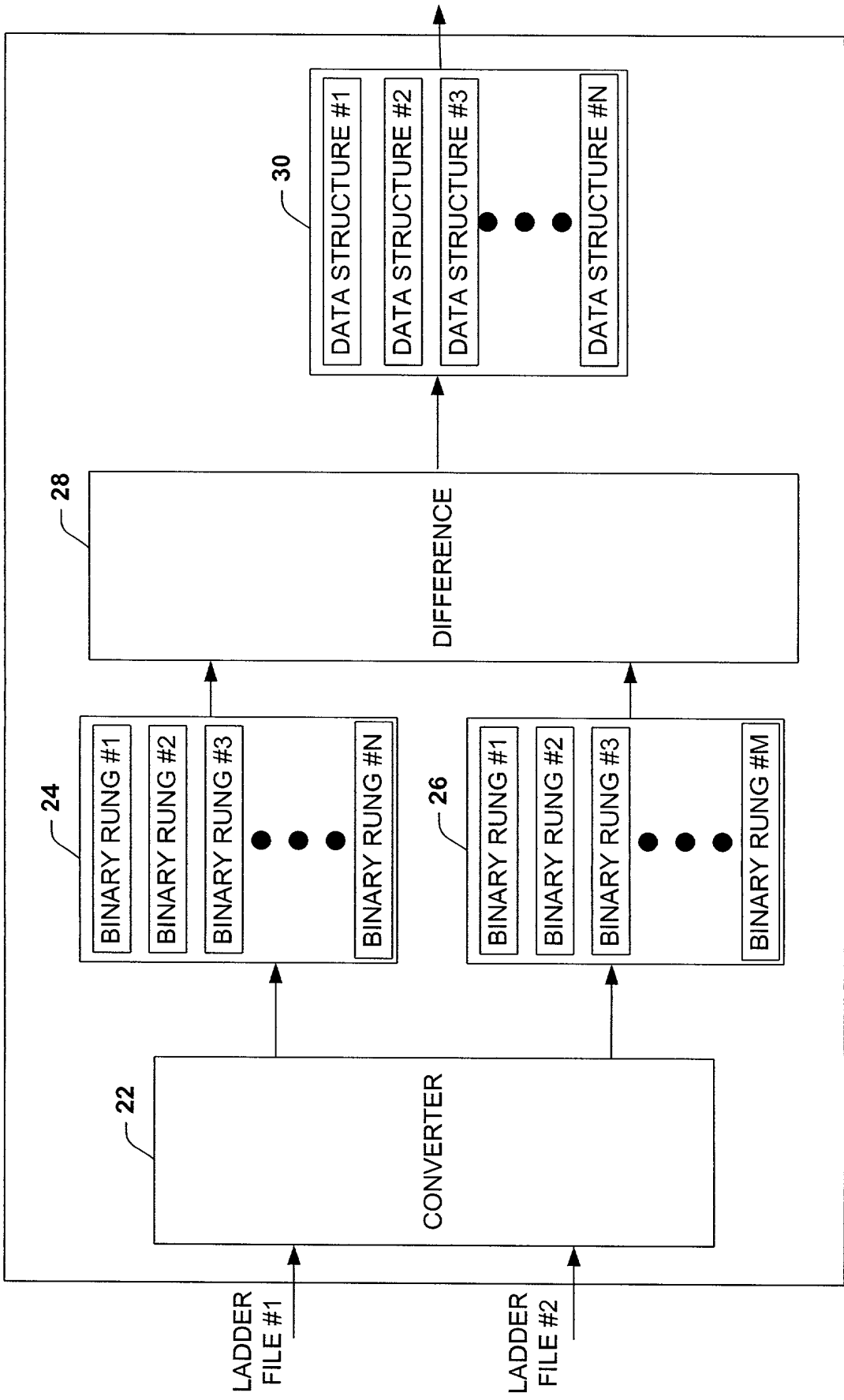

FIG. 2

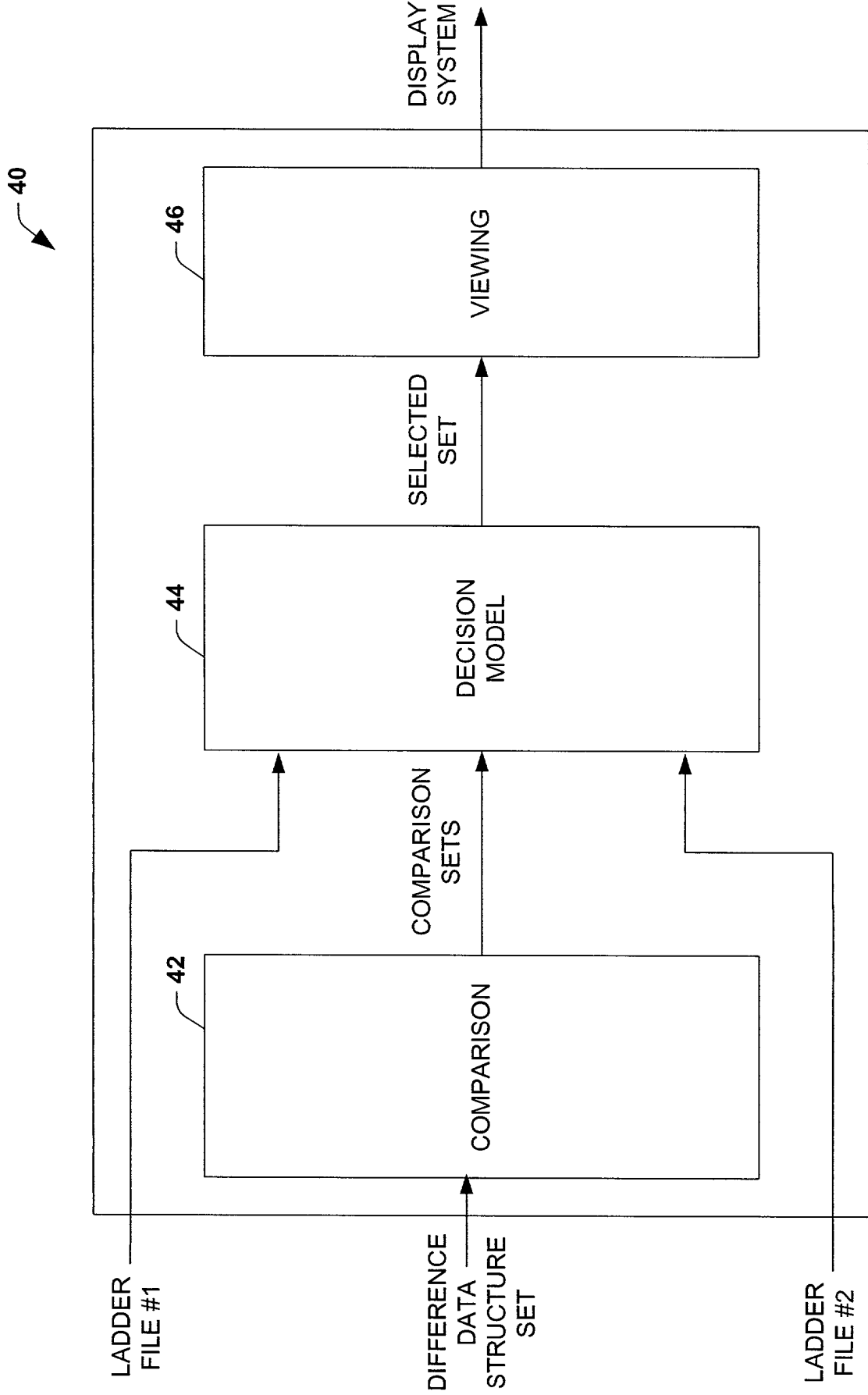

FIG. 3

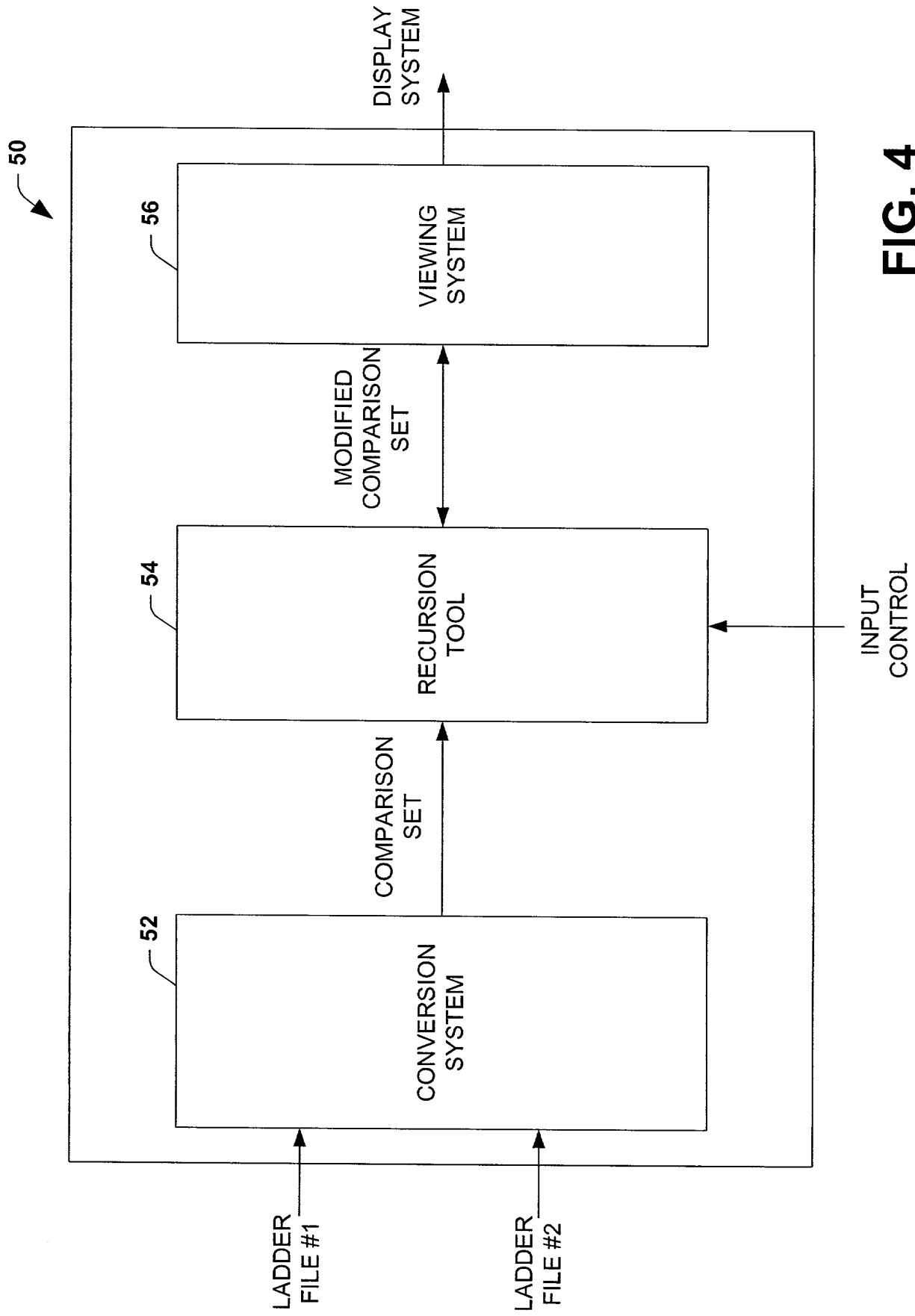

FIG. 4

U.S. PATENT AND TRADEMARK OFFICE

60

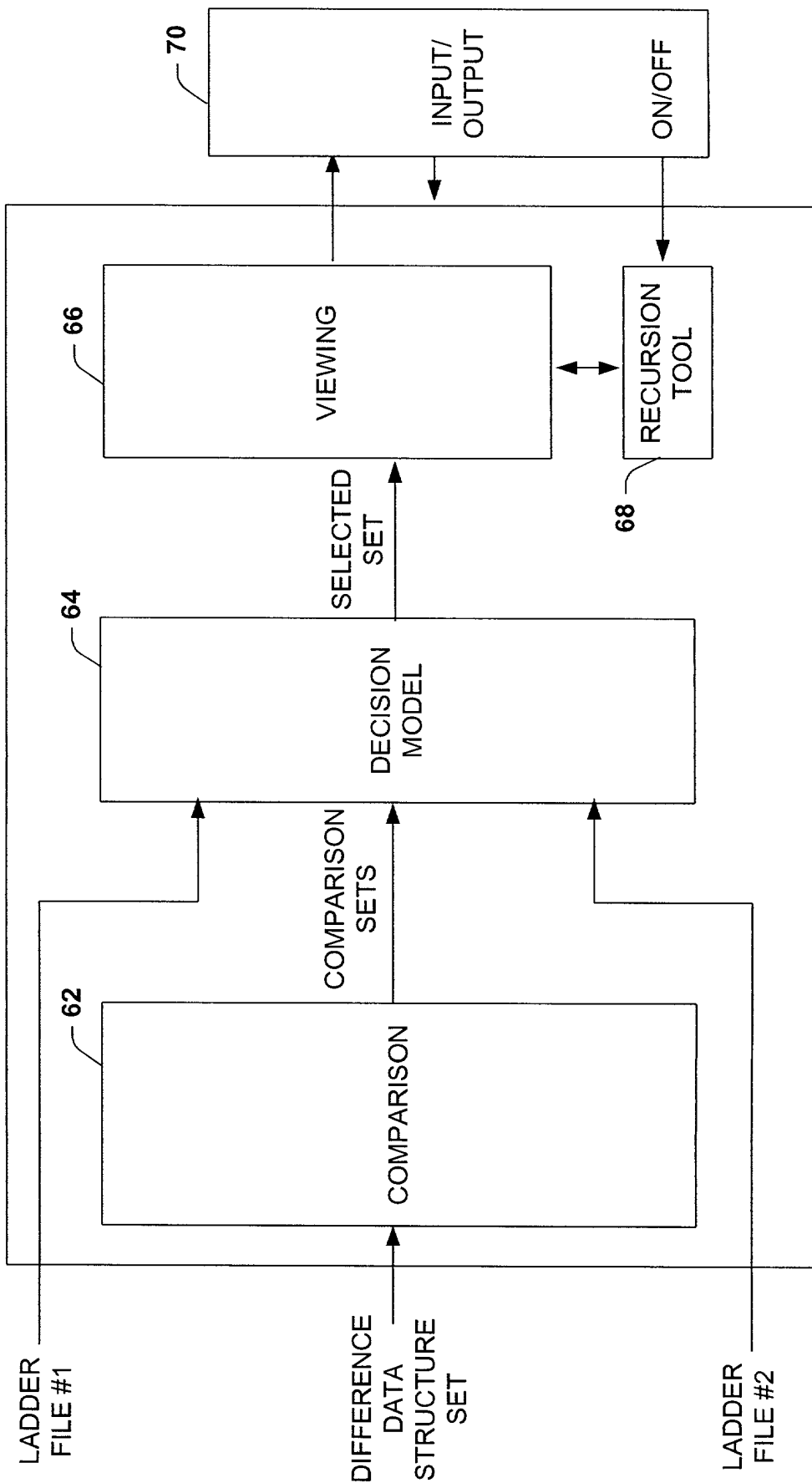

FIG. 5

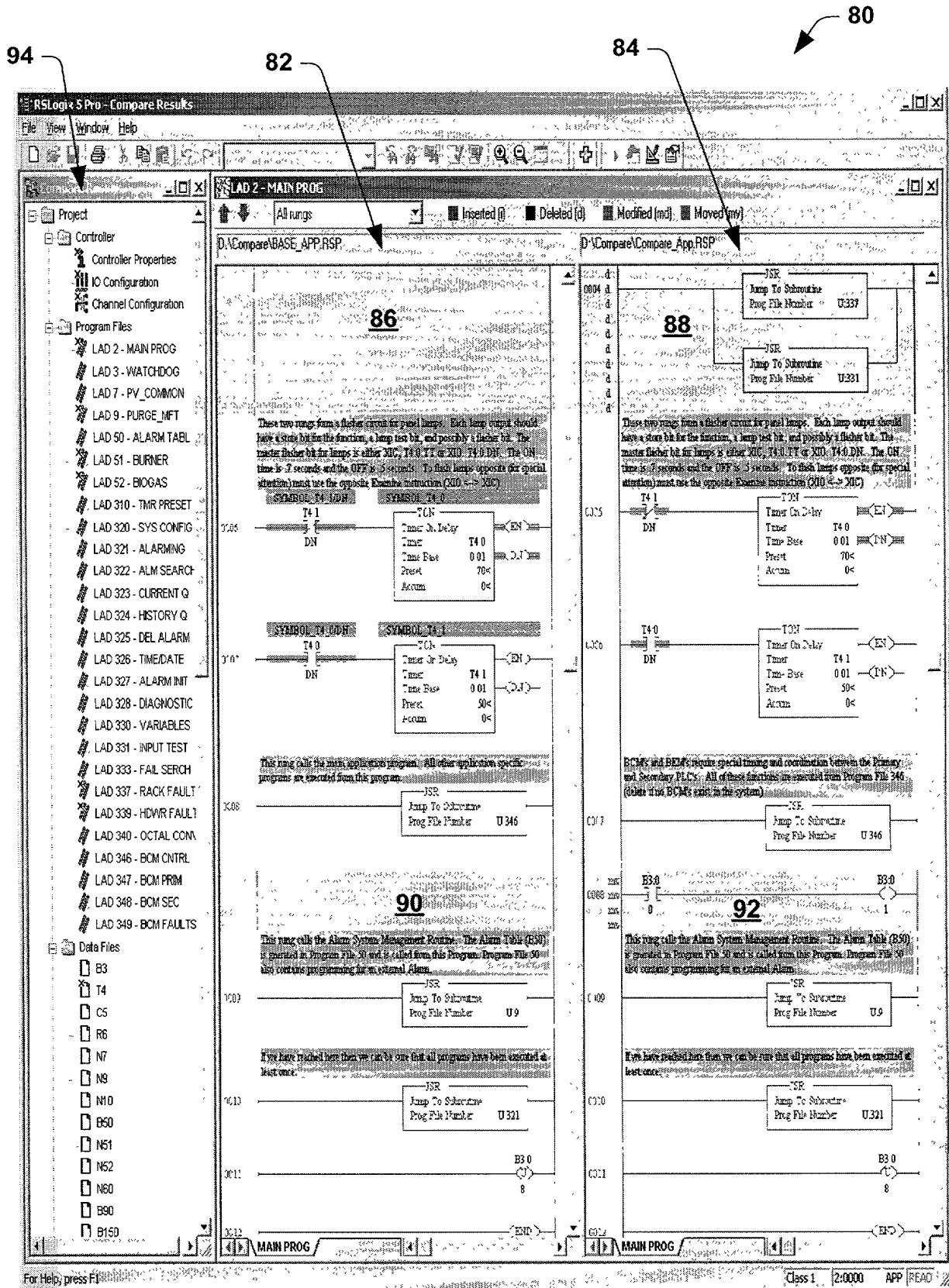

FIG. 6

120

102

104

100

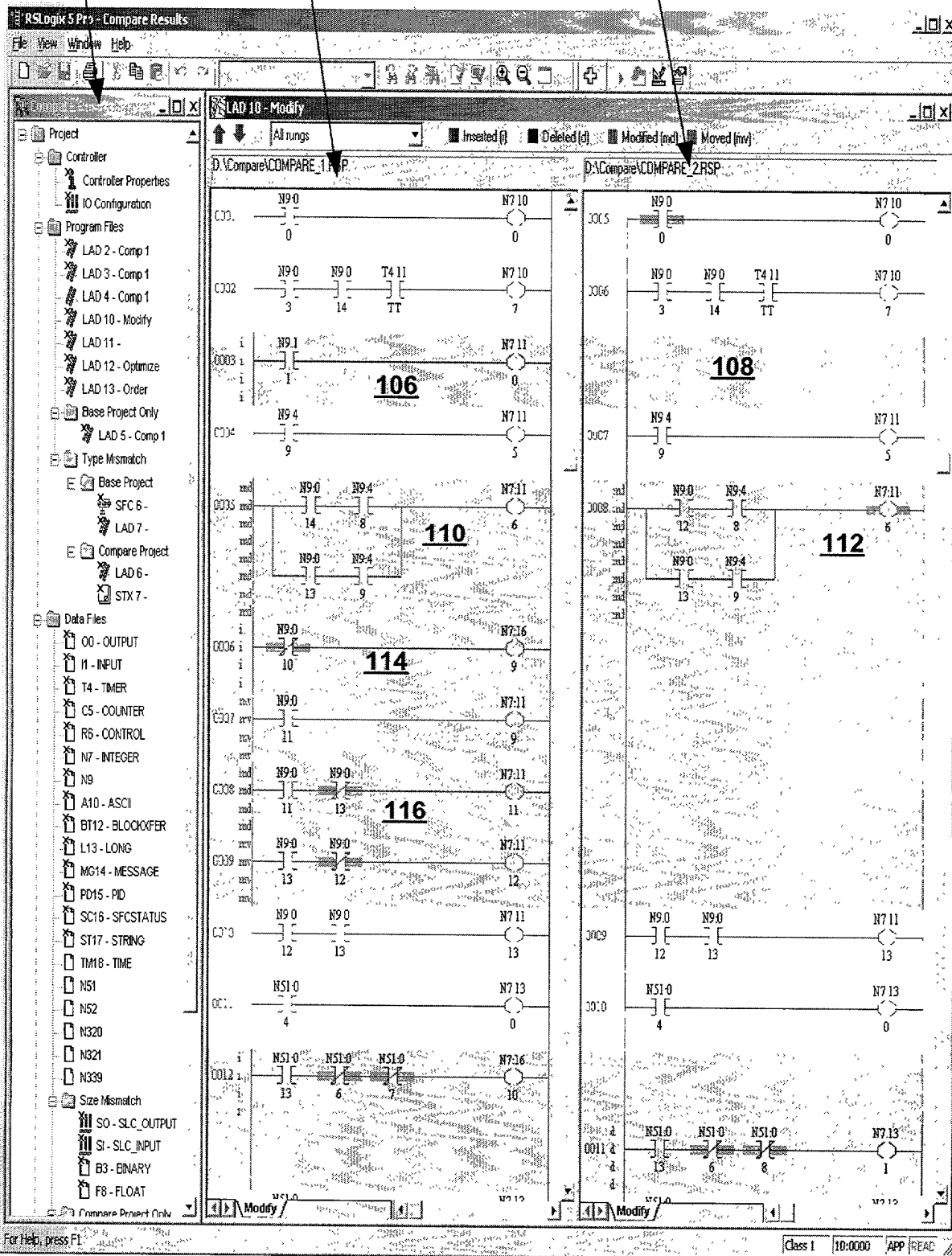

FIG. 7

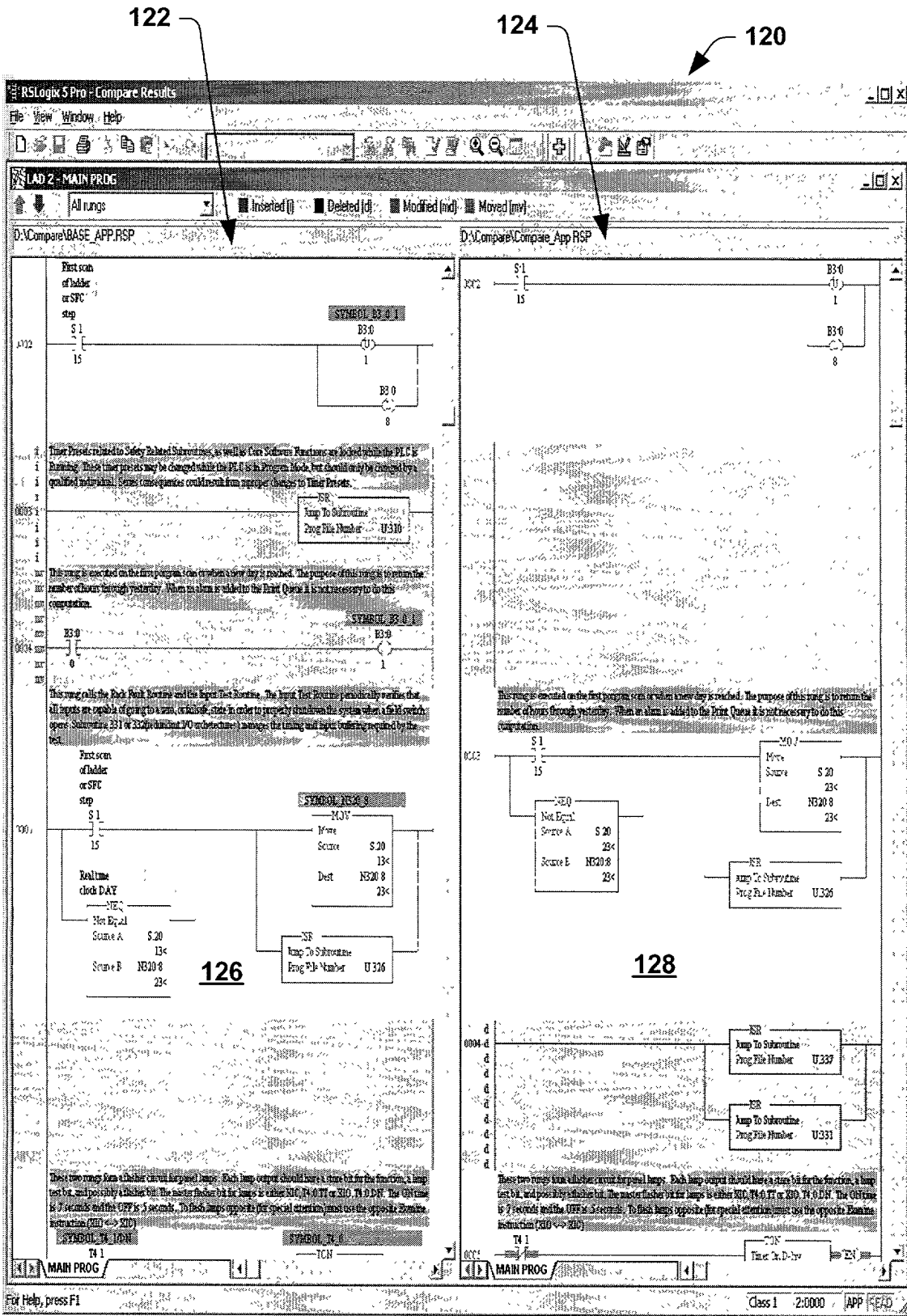

FIG. 8

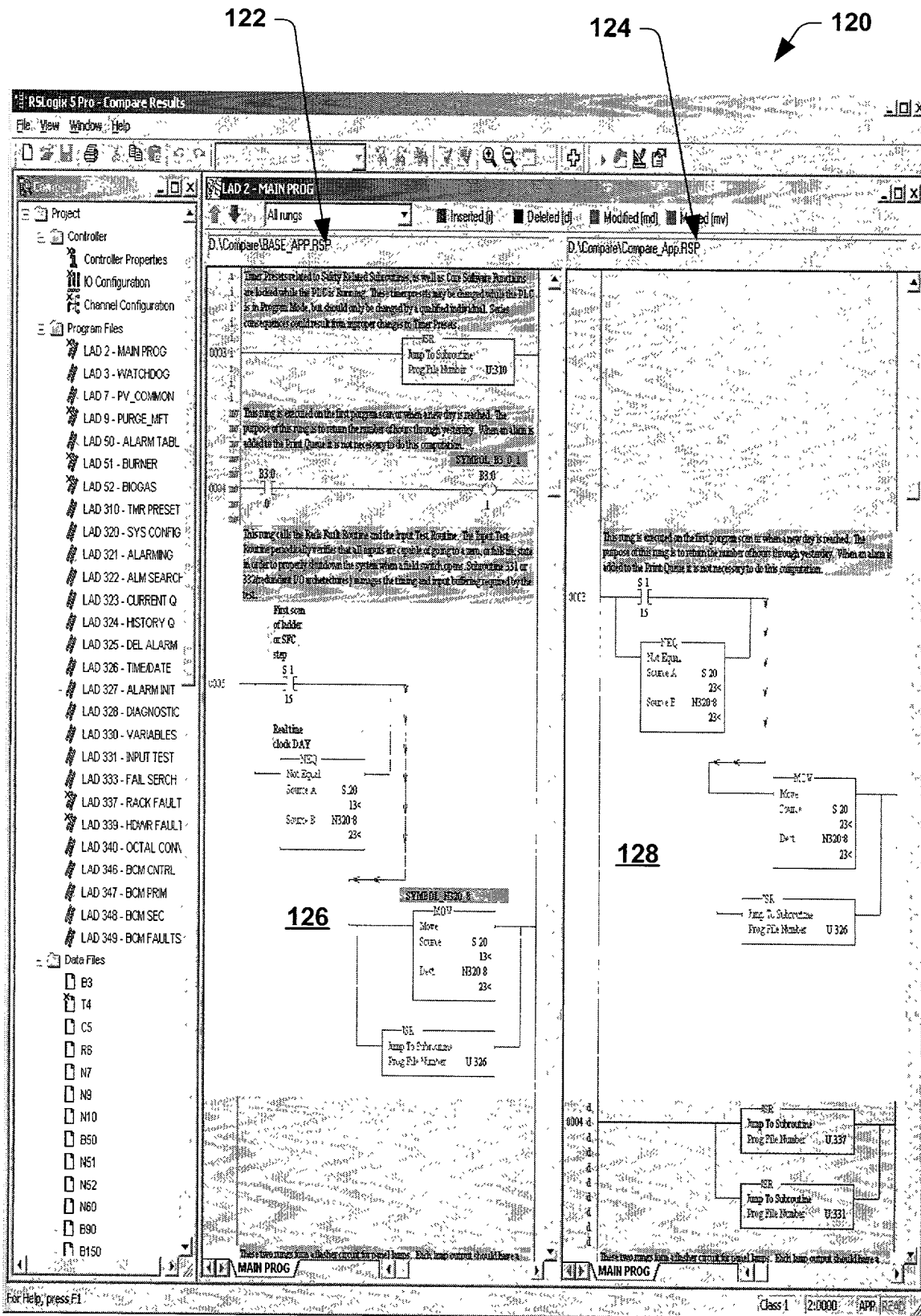

FIG. 9

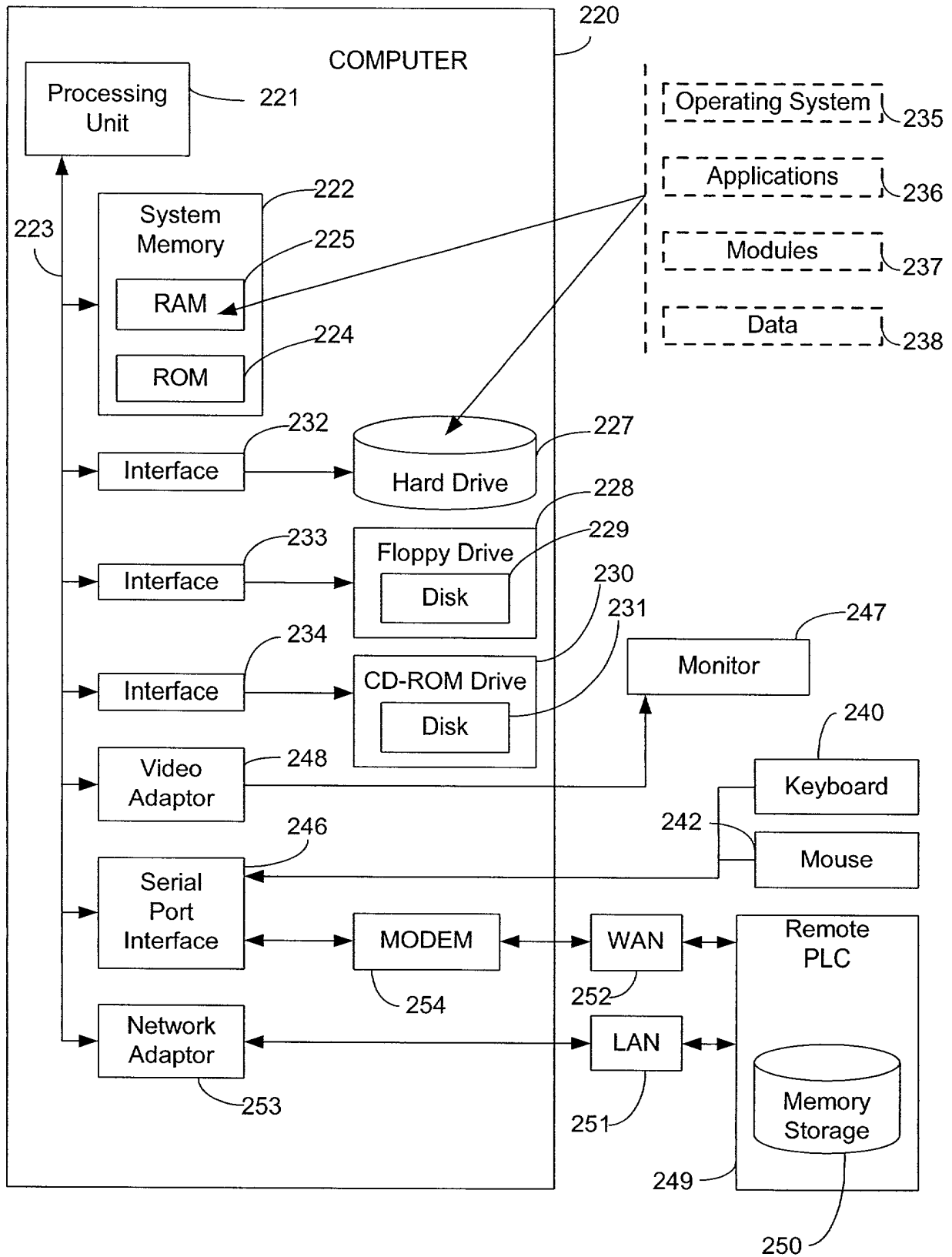

FIG. 10

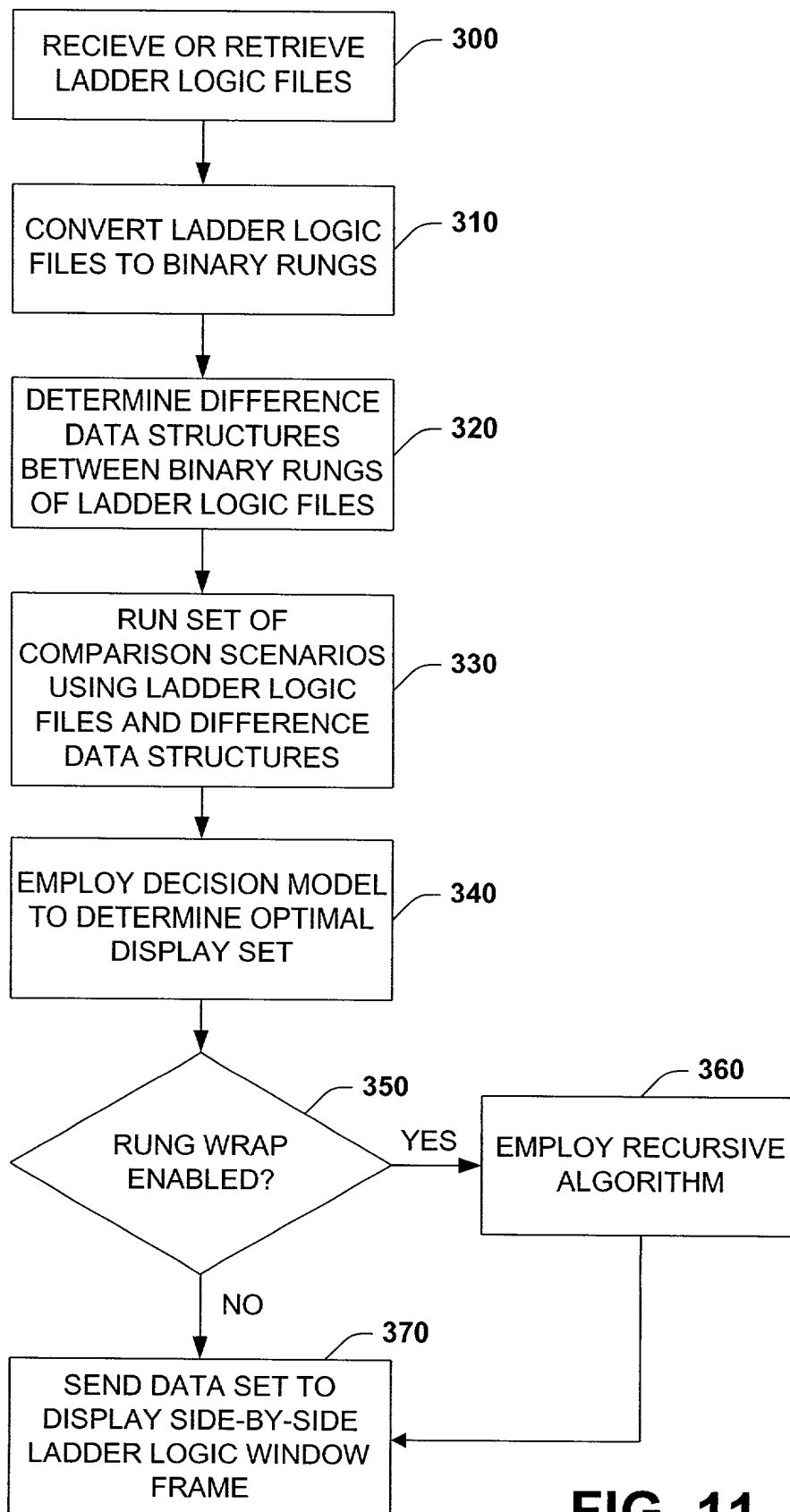

FIG. 11